

FBC23 Series Model

CONFIGURATION & DIMENSION:m/m

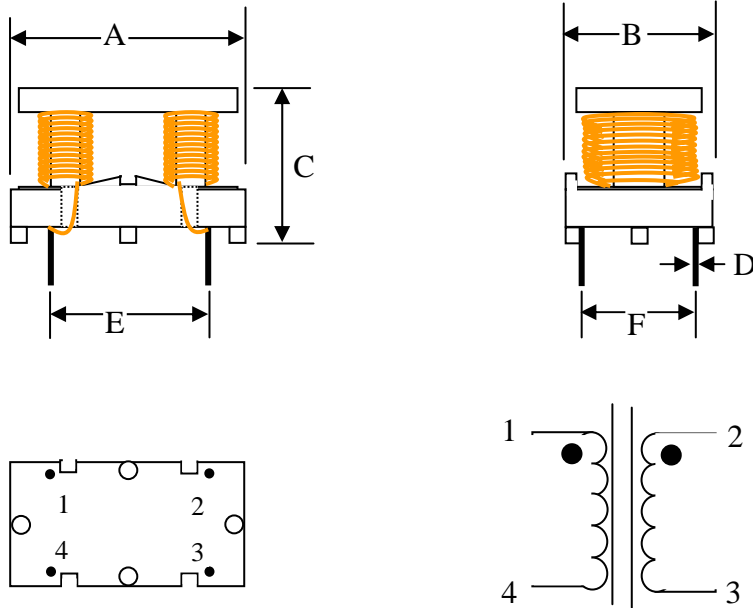

UNIT: mm

| A | B | C | D | E | F |
|----------|----------|----------|----------|----------------------|----------------------|
| 27.0 Max | 17.5 Max | 19.0 Max | 0.8±0.05 | 15.0±0.5 13.0±0.5 | 14.0±0.5 10.0±0.5 |

DIELECTRIC STRENGTH

WITHSTANDING VOLTAGE: 1.5KVAC WIND TO CORE,
1.5KVAC LINE TO LINE

INSULATION RESISTANCE: 100MΩ @ DC 500V

REFERENCE RATING:

| WIRE DIAMETER | INDUCTANCE (100KHZ/0.05V) | DC RESISTANCE | Suit for switching Power Rating |
|---------------|------------------------------|---------------|------------------------------------|
| 0.4~0.85Φ | 1~50mH | 13~300mΩ | 3~300W |

***Special or Customer designed specification was available



BIPOLAR ELECTRONIC CO.,LTD.

TEL:03-3608892

FAX:03-3608864

FBC23 Series Model

CHARACTERISTICS:

TEST CONDITION: 100KHZ/0.05V

| | INDUCTANCE (mH) Min | D.C.R (mΩ) Max | RATE CURRENT Amp(AC) ref | WIRE DIA (Φ) | TURNS (Ts) | REMARK |
|-------------|------------------------|-------------------|--------------------------------|-----------------|---------------|--------|
| FBC23085132 | 1.3 | 20 | 4.2 | 0.85 | 14.5 | |
| FBC23080162 | 1.6 | 22 | 3.7 | 0.8 | 16.5 | |
| FBC23070212 | 2.1 | 30 | 2.8 | 0.7 | 18.5 | |
| FBC23065242 | 2.4 | 35 | 2.5 | 0.65 | 19.5 | |
| FBC23060252 | 2.5 | 40 | 2.1 | 0.6 | 20.5 | |
| FBC23070422 | 4.2 | 45 | 2.8 | 0.7 | 26.5 | |
| FBC23065422 | 4.2 | 50 | 2.5 | 0.65 | 26.5 | |
| FBC23060572 | 5.7 | 65 | 2.1 | 0.6 | 30.5 | |
| FBC23055103 | 10 | 110 | 2.0 | 0.55 | 42.5 | |
| FBC23050123 | 12 | 130 | 1.4 | 0.5 | 44.5 | |
| FBC23040253 | 25 | 250 | 0.9 | 0.4 | 55.5 | |
| FBC23040503 | 50 | 350 | 0.9 | 0.4 | 73.5 | |

TYPICAL APPLICATION IN PC BLOCK DIAGRAM

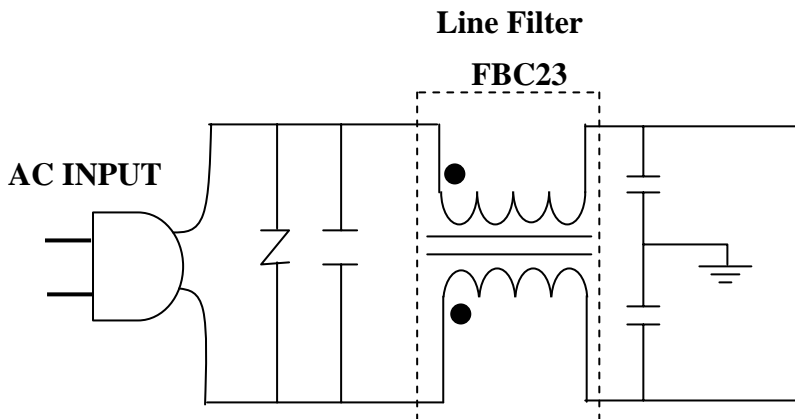

BIPOLAR ELECTRONIC CO.,LTD.

TEL:03-3608892

FAX:03-3608864

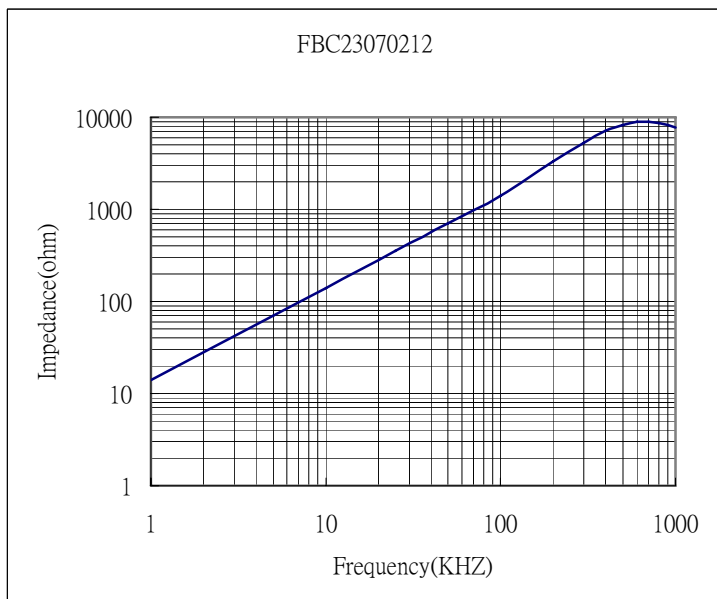
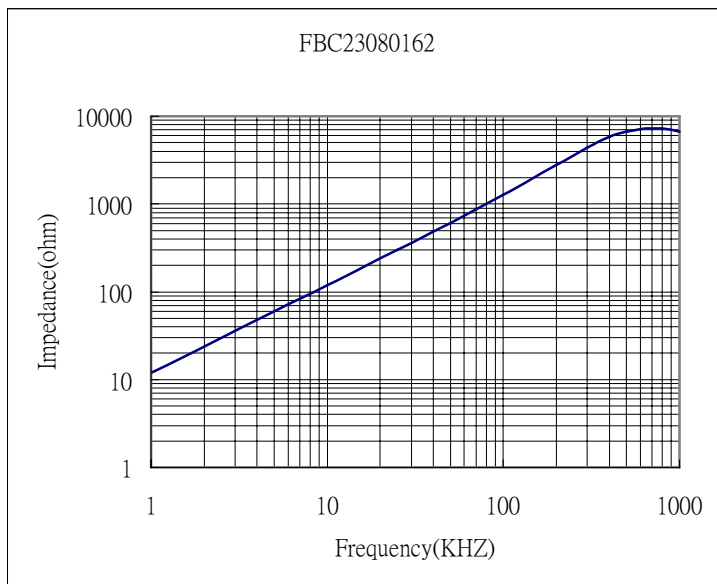
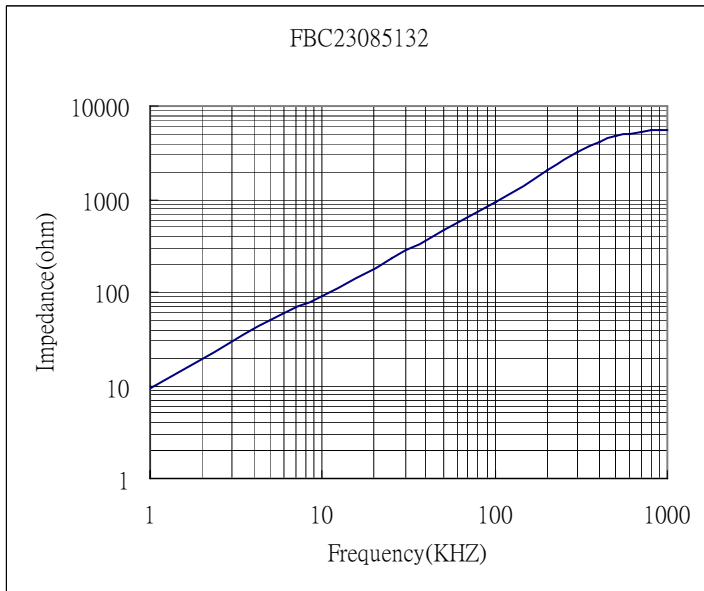

BIPOLAR ELECTRONIC CO.,LTD.

TEL:03-3608892

FAX:03-3608864

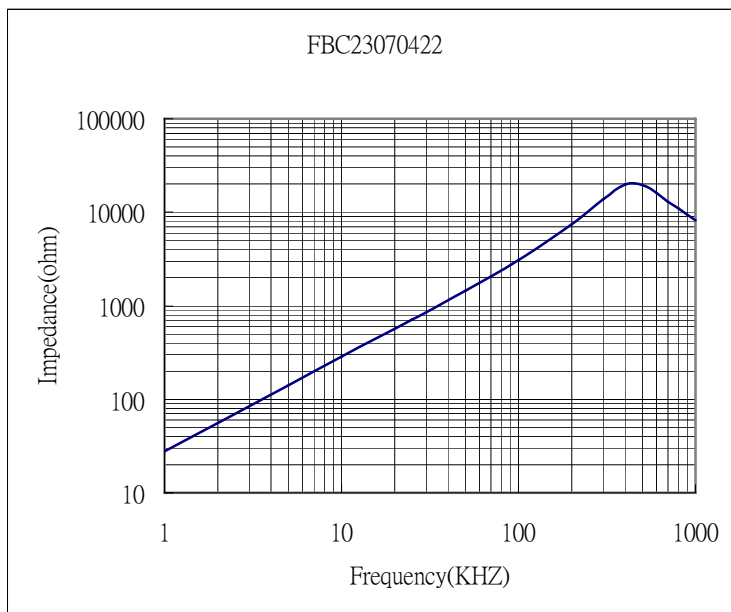
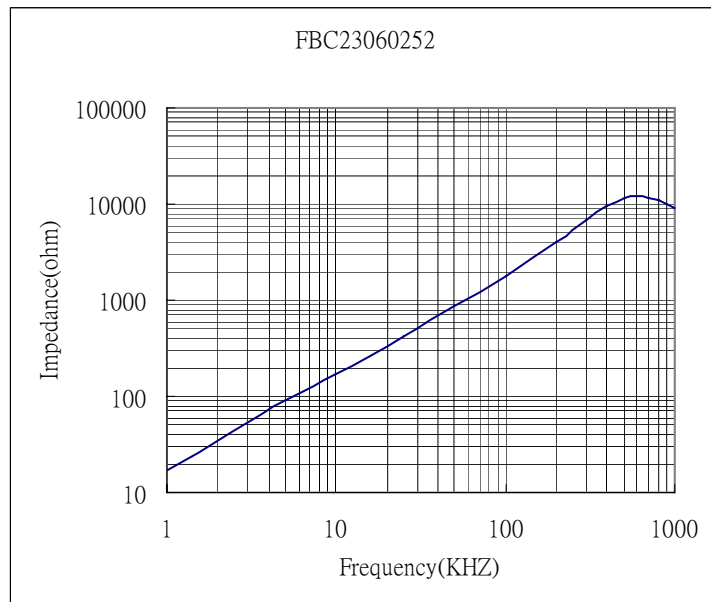
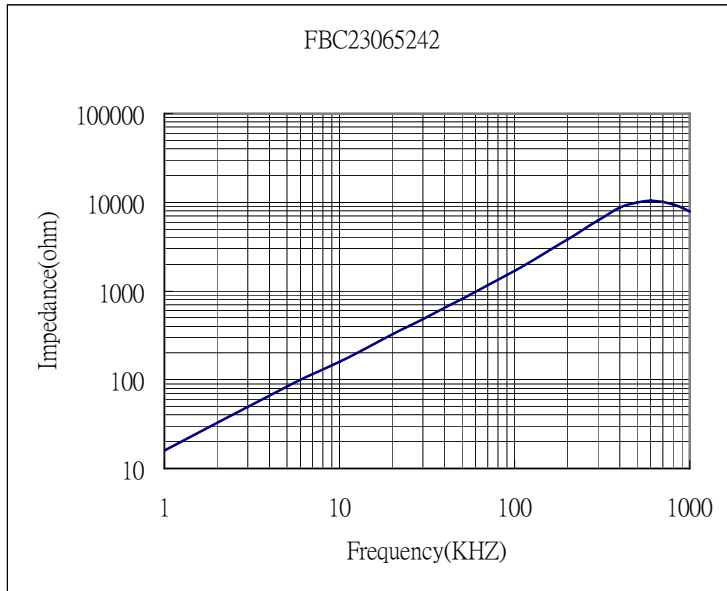

BIPOLAR ELECTRONIC CO.,LTD.

TEL:03-3608892

FAX:03-3608864

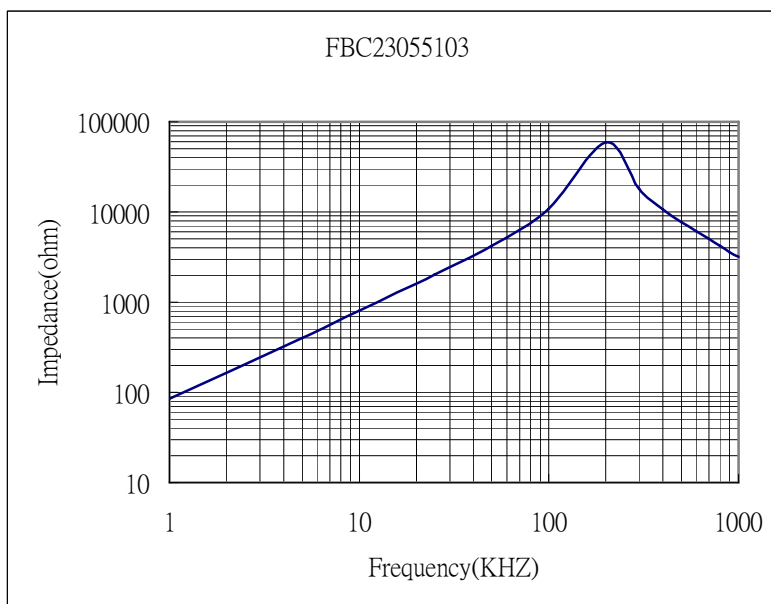
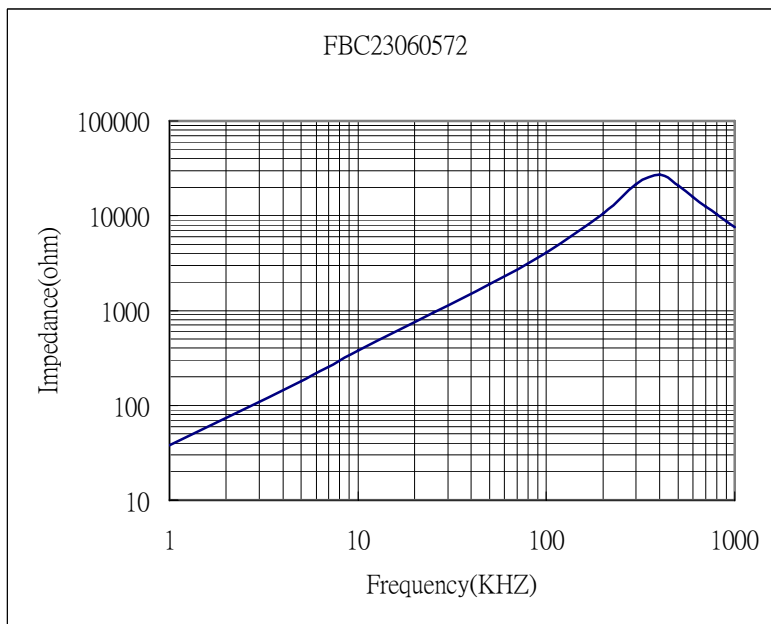
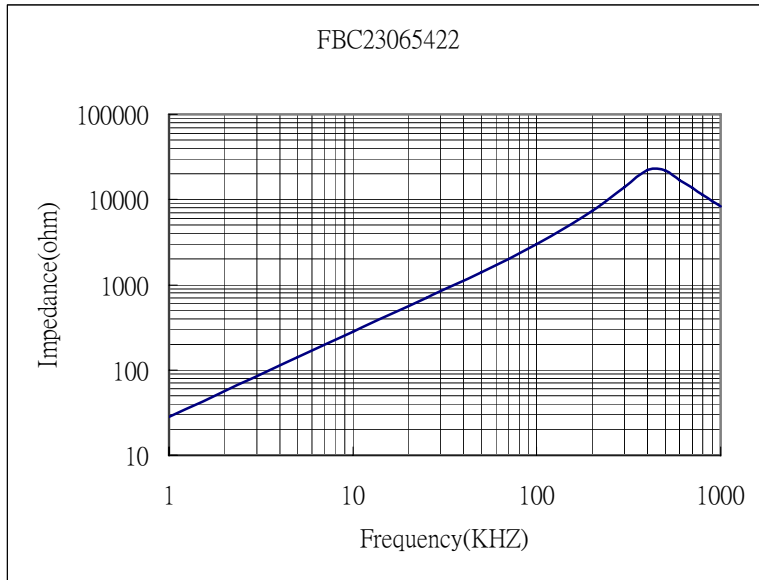

BIPOLAR ELECTRONIC CO.,LTD.

TEL:03-3608892

FAX:03-3608864

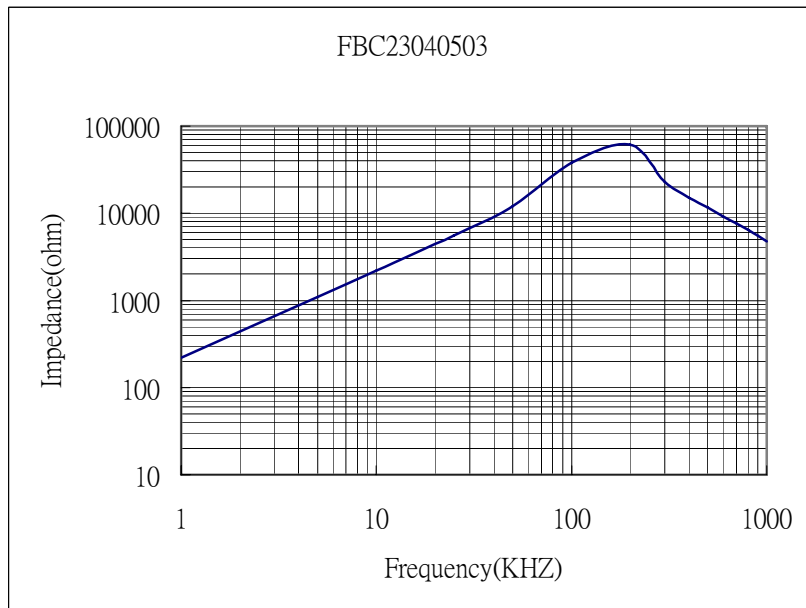
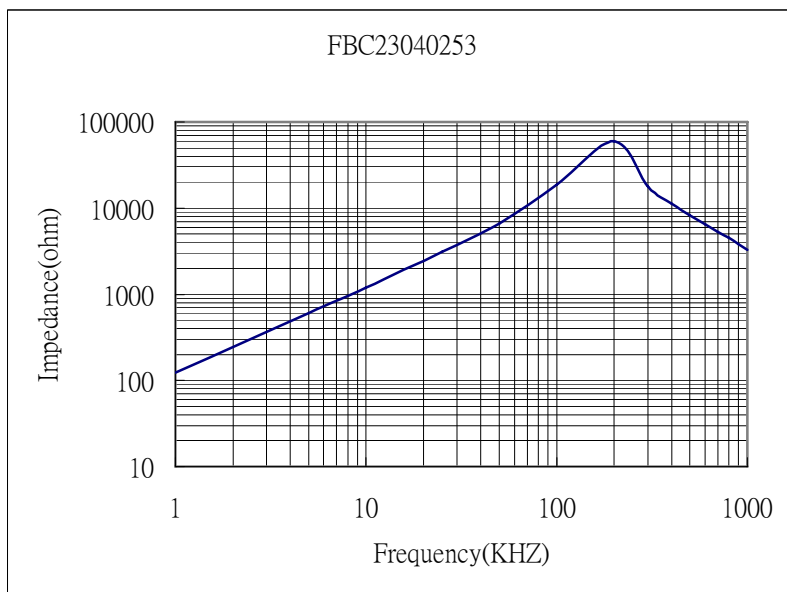
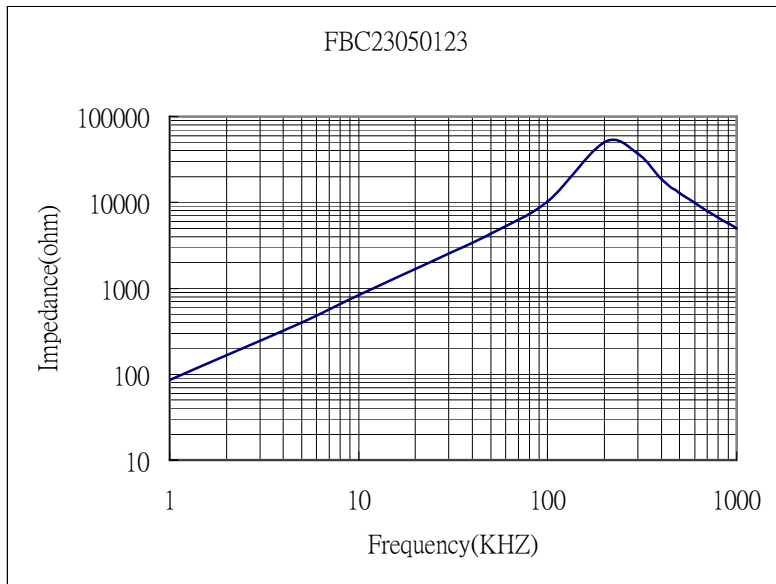

BIPOLAR ELECTRONIC CO.,LTD.

TEL:03-3608892

FAX:03-3608864